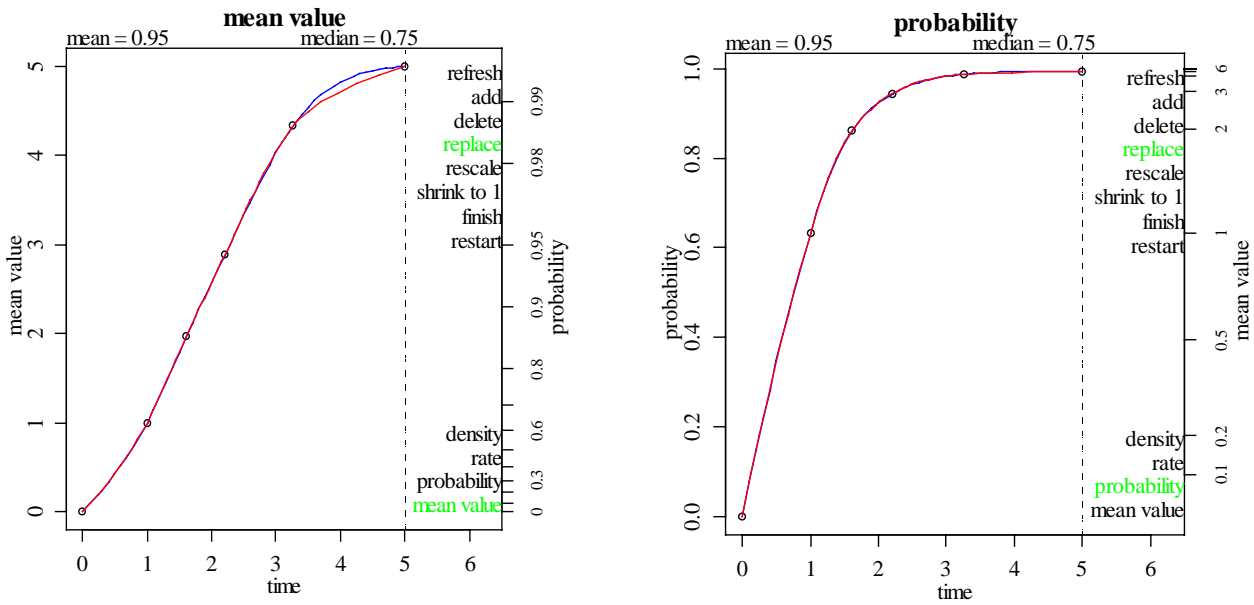
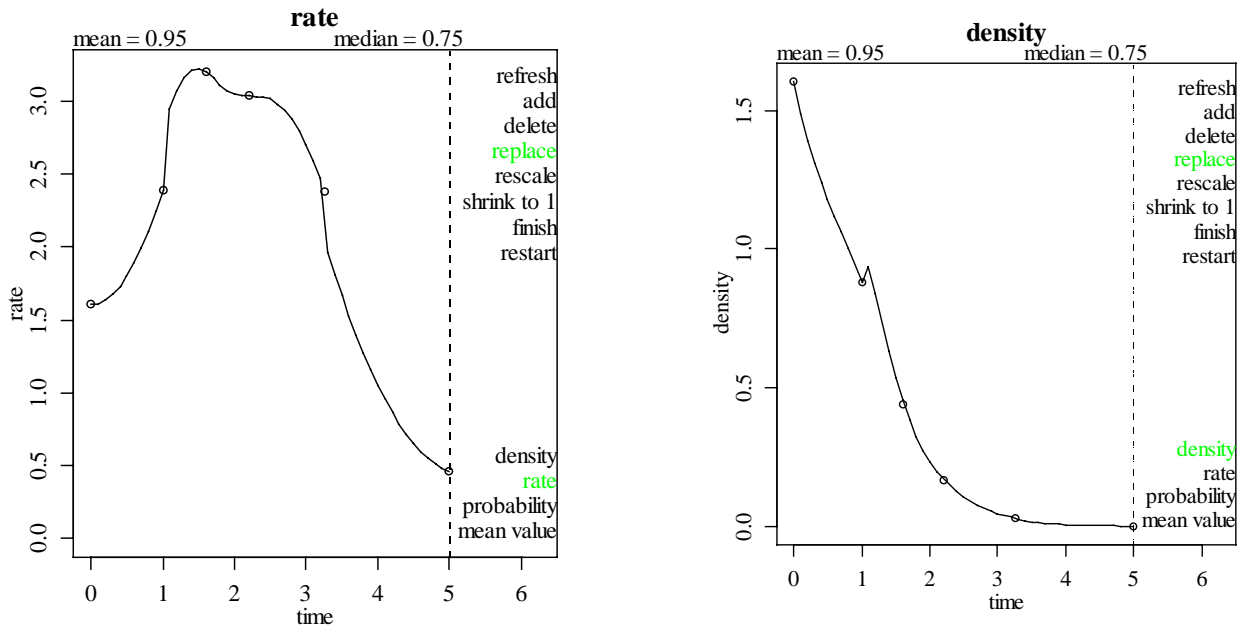

**Figure 1 Quantitative Population Ethology Simulation  
with 200 Red Scale and 100 *Aphytis* over 1000 steps**



**Figure 2 Graphical Tool for User-Specified Mean Value Curves**  
**(a) mean value curve; (b) cumulative probability curve**



**Figure 3 Derivative curves for**  
**(a) rate and (b) density. See Figure 2.**

Figure 4 Designing Temperature Change over a Day

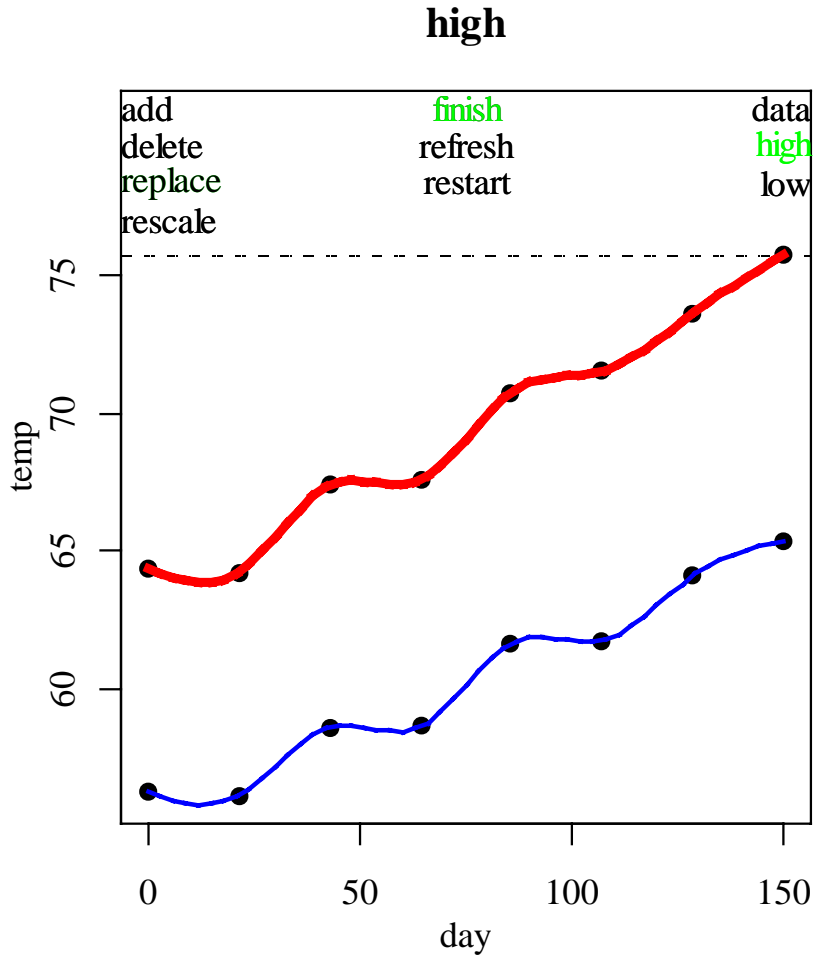
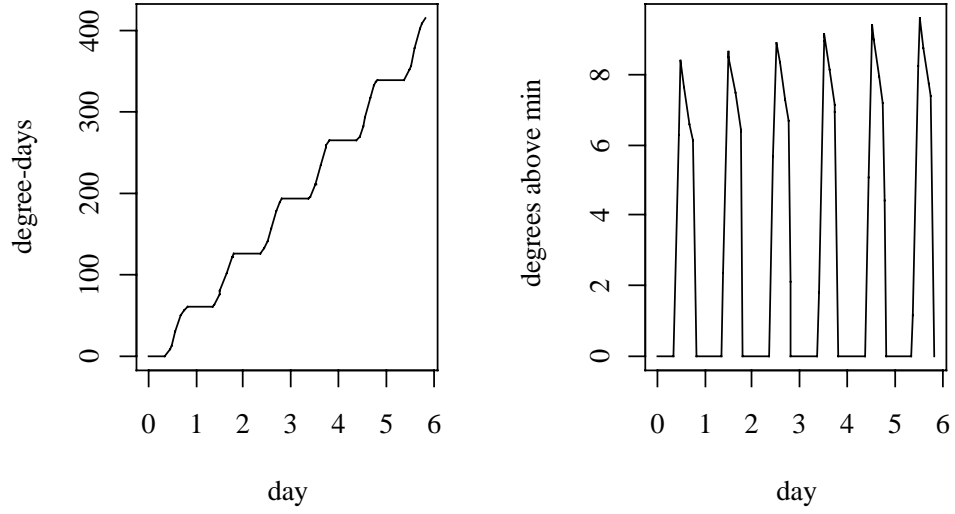
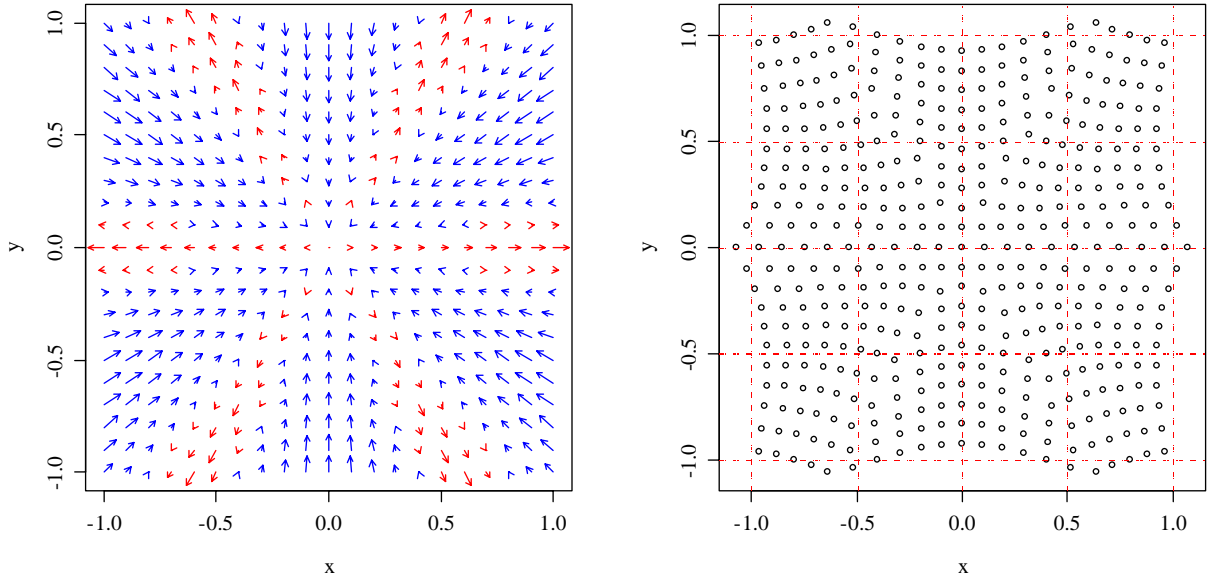

Figure 5 Graphical Tool to Adjust Daily High and Low Temperatures



**Figure 6 Cumulative and Actual Degree-Days over a Week**



**Figure 7 Distortions of Triangular Coordinate System**

Attributes (A)	Membership (S)	Events (E)
----------------	----------------	------------

**Figure 8 Individual Data Cell**

Species "A"

A(1)	S(1)	E(1)
A(2)	S(2)	E(2)
A(3)	S(3)	E(3)
empty		
A(i)	S(i)	E(i)
empty		
A(n)	S(n)	E(n)

**Figure 9 Species Data Structure**

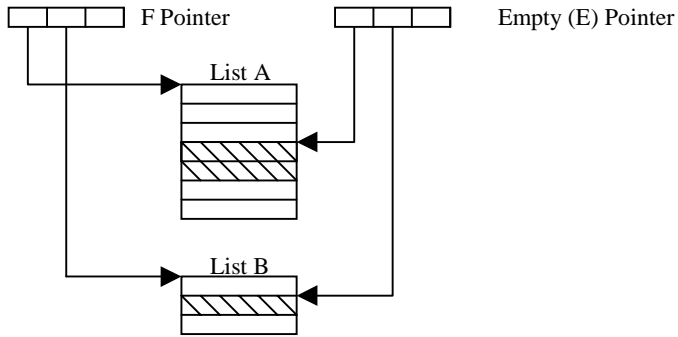

**Figure 10 Ring Sturcture Across Species**

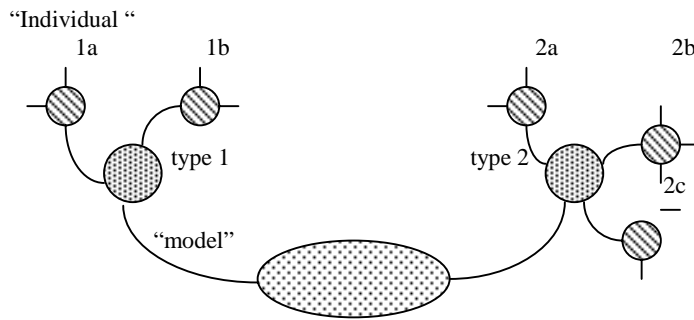

**Figure 11 Complicated Group Structure**

Ring vs. Leftist Tree Timing

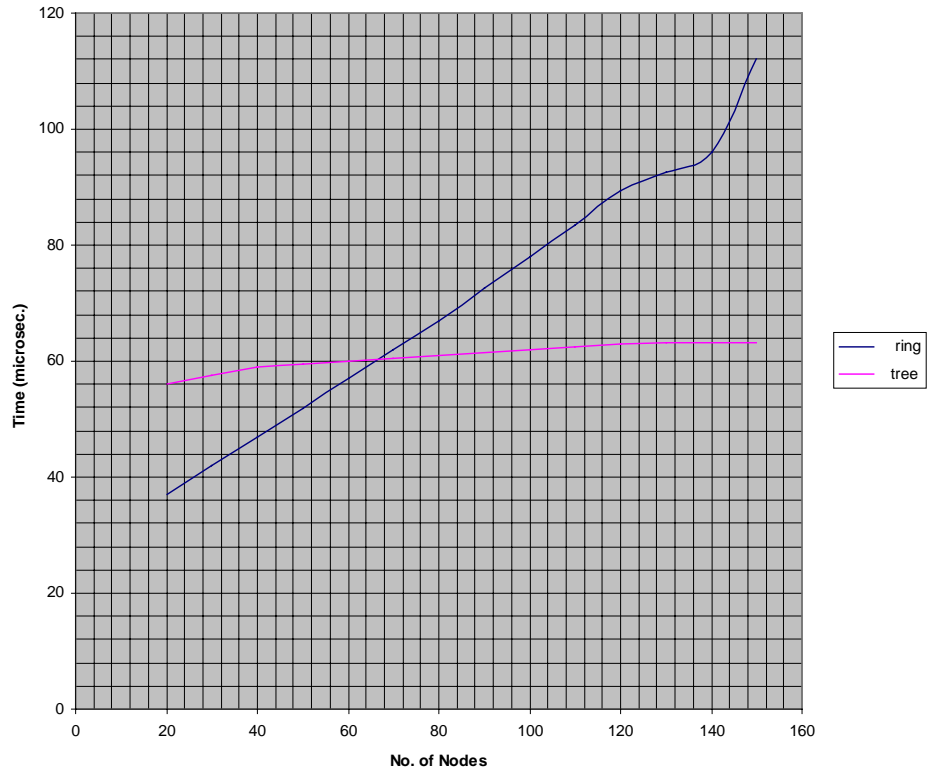
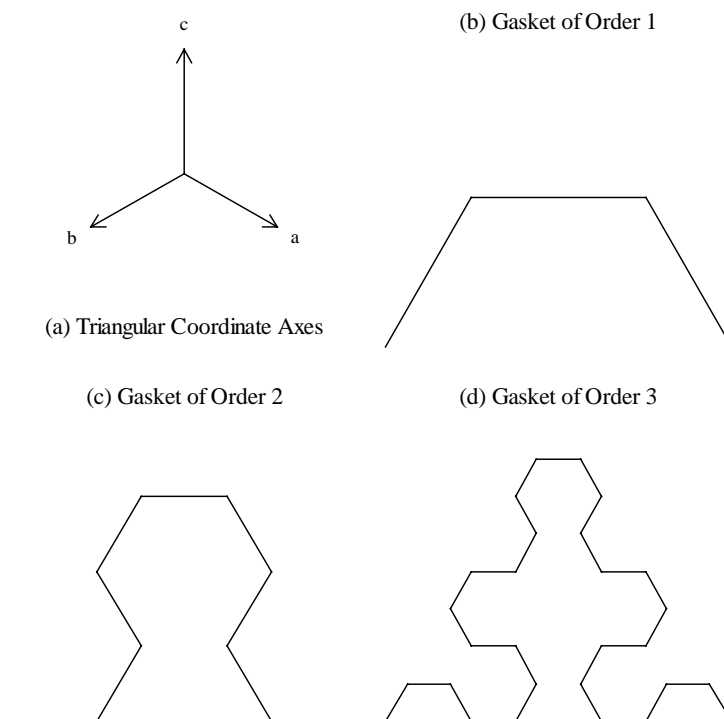
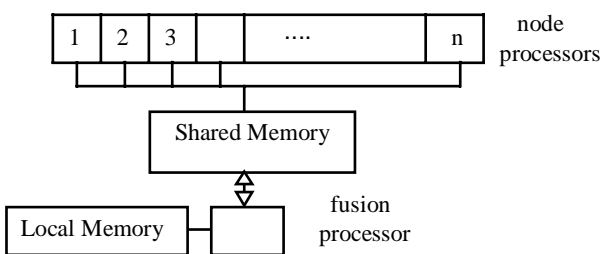

Figure 12 Ring vs. Leftist Tree Data Structures





**Figure 13 Triangular Coordinate System and Sierpinski Gaskets**



**Figure 14 Distributed Processing**