

Multiple Traits & Microarrays

1. why study multiple traits together? 2-10
 - diabetes case study
2. design issues 11-13
 - selective phenotyping
3. why are traits correlated? 14-17
 - close linkage or pleiotropy?
4. modern high throughput 18-31
 - principal components & discriminant analysis
5. graphical models 32-36
 - building causal biochemical networks

1. why study multiple traits together?

- avoid reductionist approach to biology
 - address physiological/biochemical mechanisms
 - Schmalhausen (1942); Falconer (1952)
- separate close linkage from pleiotropy
 - 1 locus or 2 linked loci?
- identify epistatic interaction or canalization
 - influence of genetic background
- establish QTL x environment interactions
- decompose genetic correlation among traits
- increase power to detect QTL

Type 2 Diabetes Mellitus

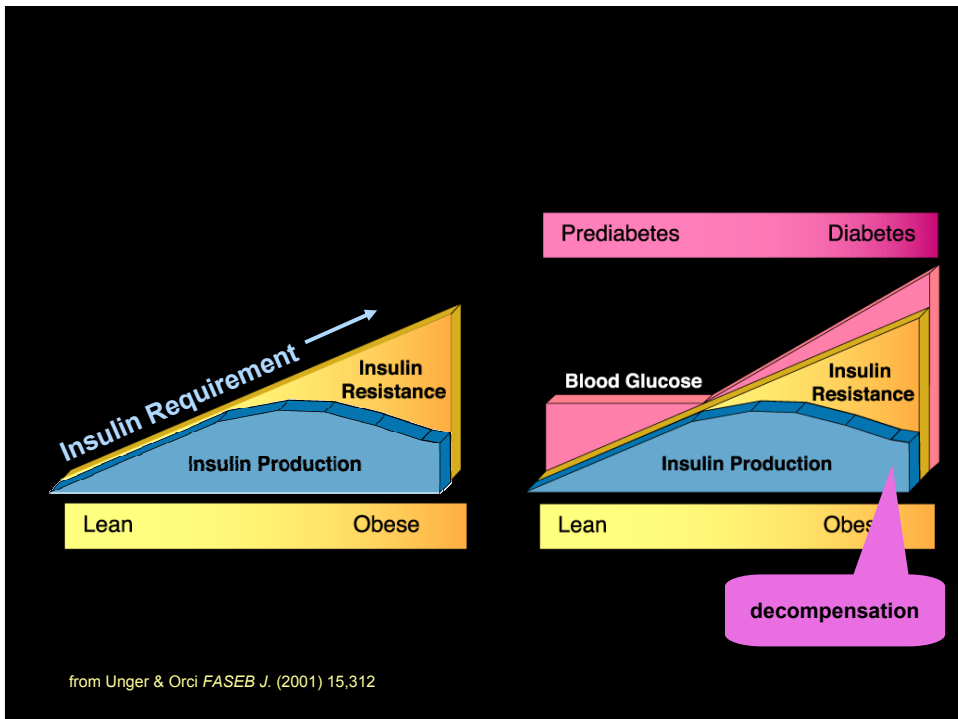
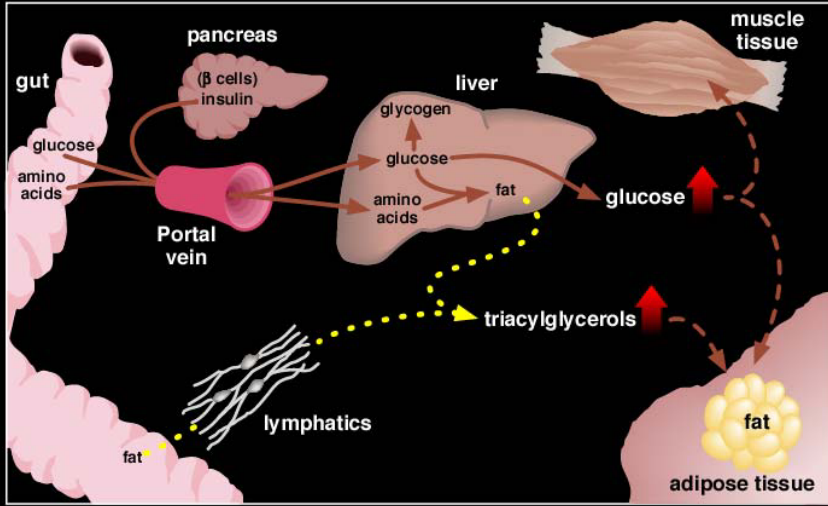

from Unger & Orci *FASEB J.* (2001) 15:312

Insulin Resistant Mice



Bill Dove



BTBR strain



glucose

insulin

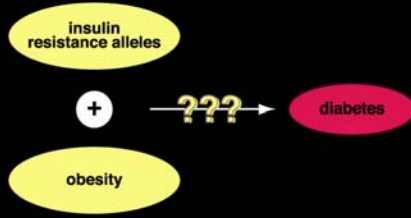

(courtesy AD Attie)

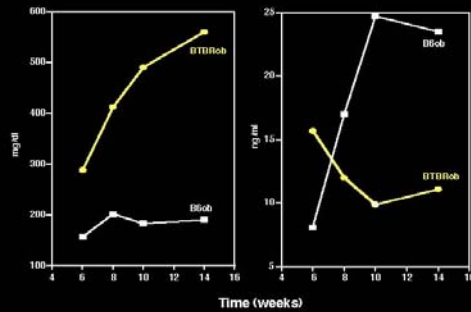

studying diabetes in an F2

- segregating cross of inbred lines
 - B6.ob x BTBR.ob → F1 → F2
 - selected mice with ob/ob alleles at leptin gene (chr 6)
 - measured and mapped body weight, insulin, glucose at various ages (Stoehr et al. 2000 *Diabetes*)
 - sacrificed at 14 weeks, tissues preserved
- gene expression data
 - Affymetrix microarrays on parental strains, F1
 - (Nadler et al. 2000 *PNAS*; Ntambi et al. 2002 *PNAS*)
 - RT-PCR for a few mRNA on 108 F2 mice liver tissues
 - (Lan et al. 2003 *Diabetes*; Lan et al. 2003 *Genetics*)
 - Affymetrix microarrays on 60 F2 mice liver tissues
 - design (Jin et al. 2004 *Genetics* tent. accept)
 - analysis (work in prep.)

why map gene expression as a quantitative trait?

- *cis*- or *trans*-action?
 - does gene control its own expression?
 - or is it influenced by one or more other genomic regions?
 - evidence for both modes (Brem et al. 2002 Science)
- simultaneously measure all mRNA in a tissue
 - ~5,000 mRNA active per cell on average
 - ~30,000 genes in genome
 - use genetic recombination as natural experiment
- mechanics of gene expression mapping
 - measure gene expression in intercross (F2) population
 - map expression as quantitative trait (QTL)
 - adjust for multiple testing



LOD map for PDI: *cis*-regulation (Lan et al. 2003)

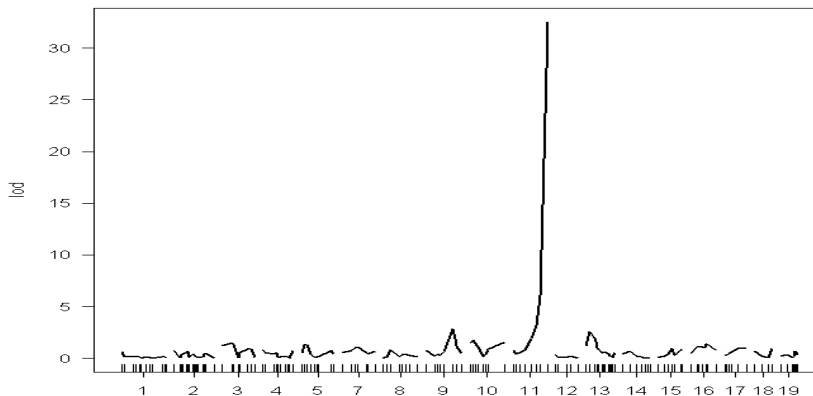

mapping microarray data

- single gene expression as trait (single QTL)
 - Dumas et al. (2000 *J Hypertens*)
- overview, wish lists
 - Jansen, Nap (2001 *Trends Gen*); Cheung, Spielman (2002); Doerge (2002 *Nat Rev Gen*); Bochner (2003 *Nat Rev Gen*)
- microarray scan via 1 QTL interval mapping
 - Brem et al. (2002 *Science*); Schadt et al. (2003 *Nature*); Yvert et al. (2003 *Nat Gen*)
 - found putative *cis*- and *trans*- acting genes
- multivariate and multiple QTL approach
 - Lan et al. (2003 *Genetics*)



2. design issues for expensive phenotypes (thanks to CF “Amy” Jin)

- microarray analysis ~ \$1000 per mouse
 - can only afford to assay 60 of 108 in panel
 - wish to not lose much power to detect QTL
- selective phenotyping
 - genotype all individuals in panel
 - select subset for phenotyping
 - previous studies can provide guide

selective phenotyping

- emphasize additive effects in F2
 - F2 design: 1QQ:2Qq:1qq
 - best design for additive only: 1QQ:1Qq
 - drop heterozygotes (Qq)
 - reduce sample size by half with no power loss
- emphasize general effects in F2
 - best design: 1QQ:1Qq:1qq
 - drop half of heterozygotes (25% reduction)
- multiple loci
 - same idea but care is needed
 - drop 7/16 of sample for two unlinked loci

is this relevant to large QTL studies?

- why not phenotype entire mapping panel?
 - selectively phenotype subset of 50-67%
 - may capture most effects
 - with little loss of power
- two-stage selective phenotyping?
 - genotype & phenotype subset of 100-300
 - could selectively phenotype using whole genome
 - QTL map to identify key genomic regions
 - selectively phenotype subset using key regions

3. why are traits correlated?

- environmental correlation
 - non-genetic, controllable by design
 - historical correlation (learned behavior)
 - physiological correlation (same body)
- genetic correlation
 - pleiotropy
 - one gene, many functions
 - common biochemical pathway, splicing variants
 - close linkage
 - two tightly linked genes
 - genotypes Q are collinear

interplay of pleiotropy & correlation

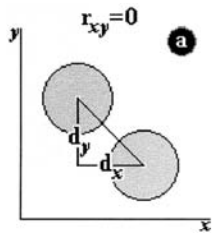

pleiotropy only

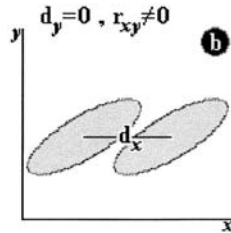

correlation only

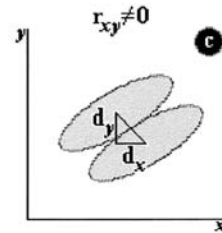

both

Korol et al. (2001)

3 correlated traits (Jiang Zeng 1995)

ellipses centered on genotypic value
width for nominal frequency
main axis angle environmental correlation
3 QTL, F2
27 genotypes

note signs of
genetic and
environmental
correlation

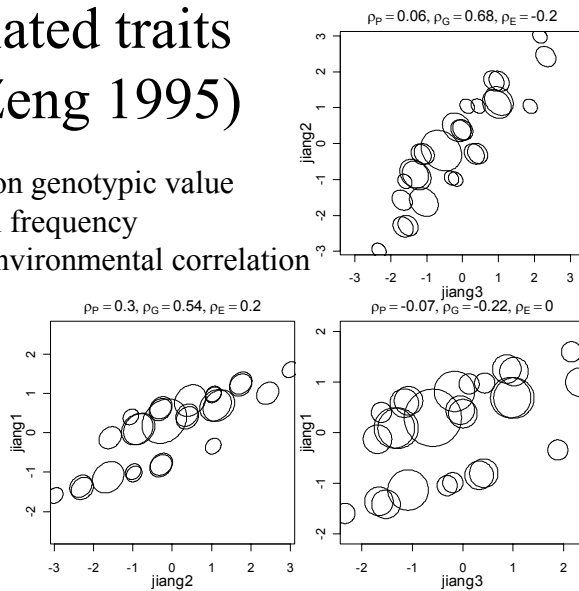

pleiotropy or close linkage?

2 traits, 2 qtl/trait
pleiotropy @ 54cM
linkage @ 114,128cM
Jiang Zeng (1995)

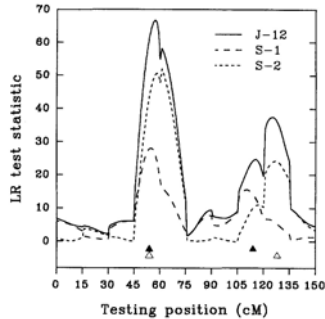

Traits

NCSU QTL II: Yandell © 2005

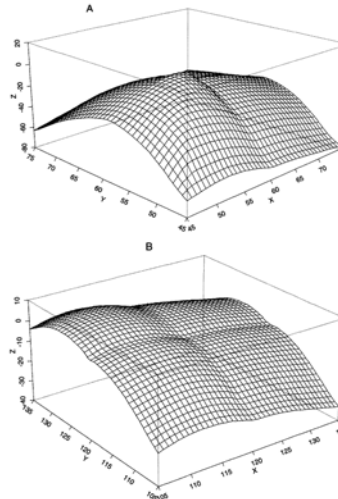

FIGURE 2—Two-dimensional log-likelihood surfaces (expressed as deviation from the maximum of the log-likelihoods on the diagonal) for the test of pleiotropy vs. close linkage are presented for two regions: the region between 45 and 75 cM of Figure 1 (A) and the region between 105 and 135 cM (B). X is the testing position for a QTL affecting trait 1 and Y is the testing position for a QTL affecting trait 2. On the diagonal of X-Y plane, two QTL are located in the same position and statistically are treated as one pleiotropic QTL. Z is the likelihood ratio test statistic scaled to zero at the maximum point of the diagonal.

17

4. modern high throughput biology

- measuring the molecular dogma of biology
 - DNA → RNA → protein → metabolites
 - measured one at a time only a few years ago
- massive array of measurements on whole systems (“omics”)
 - thousands measured per individual (experimental unit)
 - all (or most) components of system measured simultaneously
 - whole genome of DNA: genes, promoters, etc.
 - all expressed RNA in a tissue or cell
 - all proteins
 - all metabolites
- systems biology: focus on network interconnections
 - chains of behavior in ecological community
 - underlying biochemical pathways
- genetics as one experimental tool
 - perturb system by creating new experimental cross
 - each individual is a unique mosaic

Traits

NCSU QTL II: Yandell © 2005

18

coordinated expression in mouse genome (Schadt et al. 2003)

expression pleiotropy in yeast genome (Brem et al. 2002)

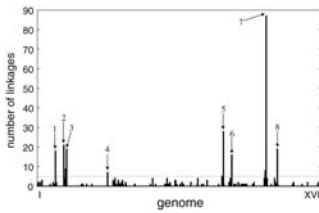

Traits

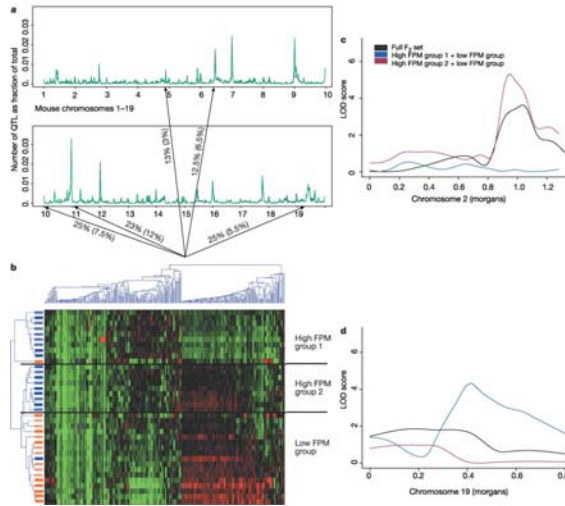

NCSU QTL II: Yandell © 2005

19

finding heritable traits (from Christina Kendzierski)

- reduce 30,000 traits to 300-3,000 heritable traits

- probability a trait is heritable

$$\text{pr}(H|Y,Q) = \text{pr}(Y|Q,H) \text{pr}(H|Q) / \text{pr}(Y|Q)$$

Bayes rule

$$\text{pr}(Y|Q) = \text{pr}(Y|Q,H) \text{pr}(H|Q) + \text{pr}(Y|Q, \text{not } H) \text{pr}(\text{not } H|Q)$$

- phenotype averaged over genotypic mean μ

$$\text{pr}(Y|Q, \text{not } H) = f_0(Y) = \int f(Y|G) \text{pr}(G) dG$$

if not H

$$\text{pr}(Y|Q, H) = f_1(Y|Q) = \prod_q f_0(Y_q)$$

if heritable

$$Y_q = \{Y_i | Q_i = q\} = \text{trait values with genotype } Q=q$$

Traits

NCSU QTL II: Yandell © 2005

20

hierarchical model for expression phenotypes

(EB arrays: Christina Kendziorski)

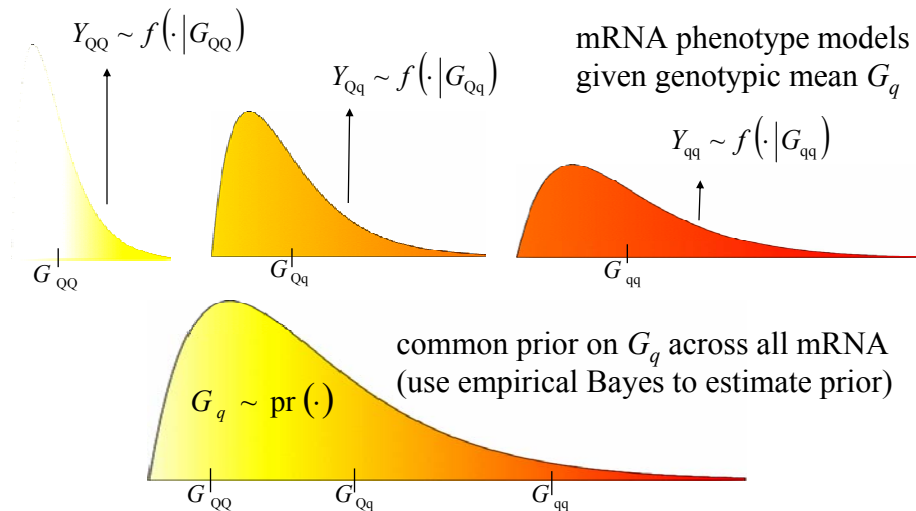

NCSU QTL II: Yandell © 2005

21

expression meta-traits: pleiotropy

- reduce 3,000 heritable traits to 3 meta-traits(!)
- what are expression meta-traits?
 - pleiotropy: a few genes can affect many traits
 - transcription factors, regulators
 - weighted averages: $Z = YW$
 - principle components, discriminant analysis
- infer genetic architecture of meta-traits
 - model selection issues are subtle
 - missing data, non-linear search
 - what is the best criterion for model selection?
 - time consuming process
 - heavy computation load for many traits
 - subjective judgement on what is best

Traits

NCSU QTL II: Yandell © 2005

22

PC for two correlated mRNA

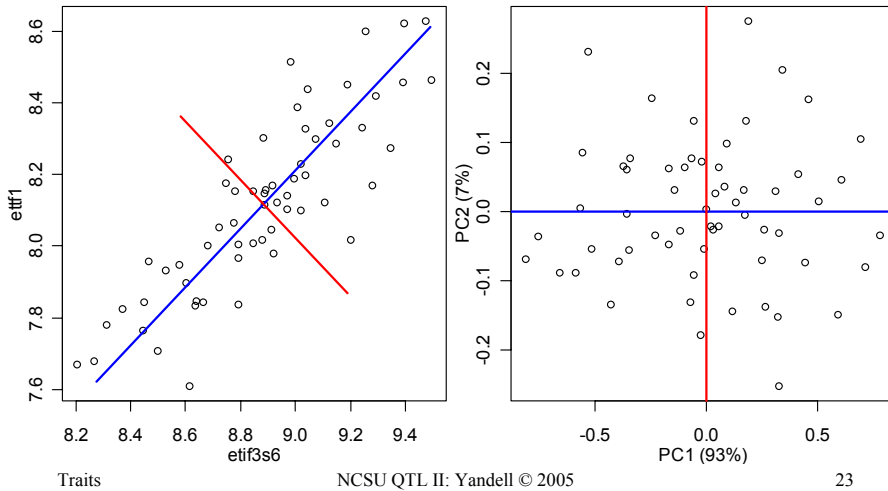

PC across microarray functional groups

Affy chips on 60 mice
~40,000 mRNA

2500+ mRNA show DE
(via EB arrays with
marker regression)

1500+ organized in
85 functional groups
2-35 mRNA / group

which are interesting?
examine PC1, PC2

circle size = # unique mRNA

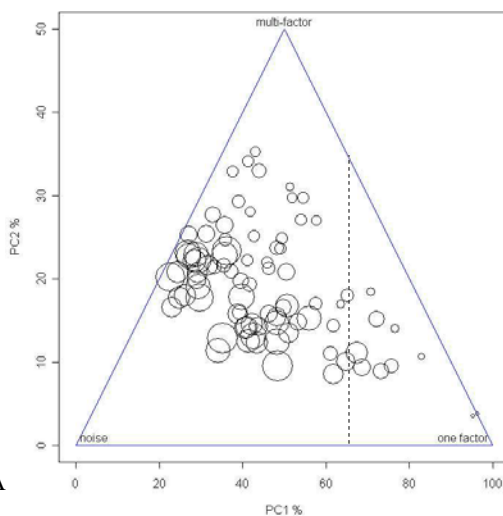

Traits

NCSU QTL II: Yandell © 2005

24

84 PC meta-traits by functional group

focus on 2 interesting groups

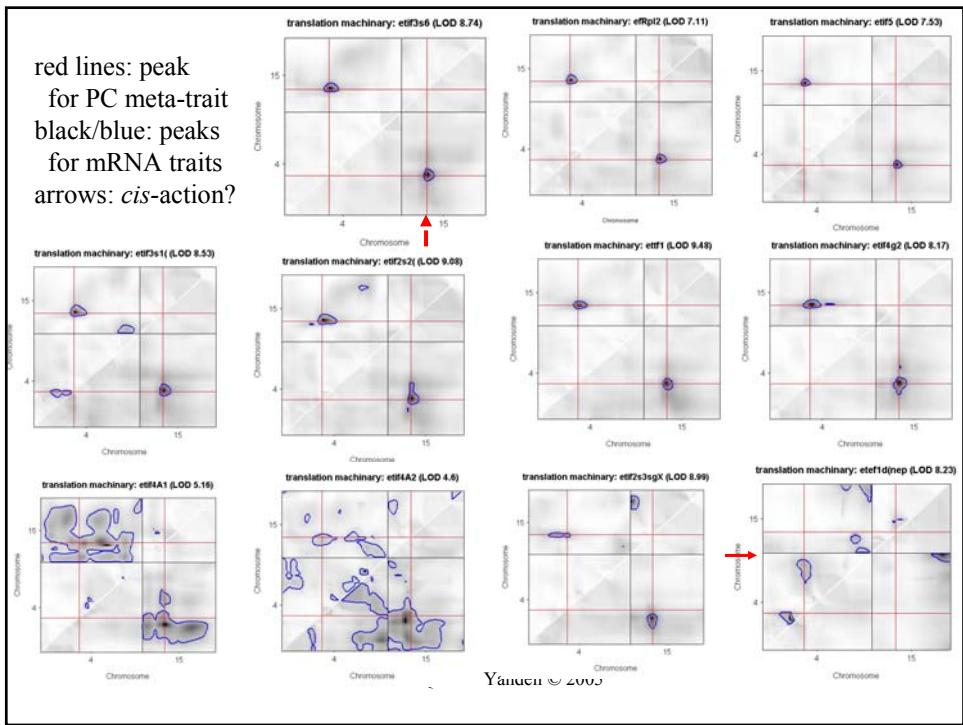
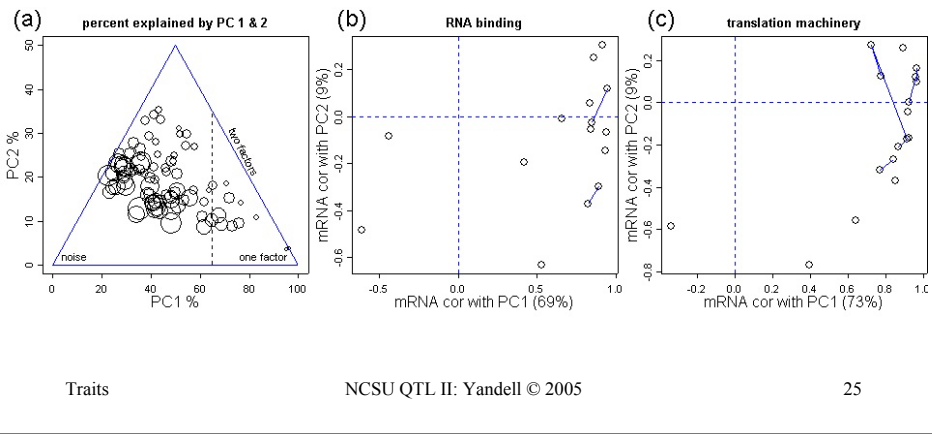

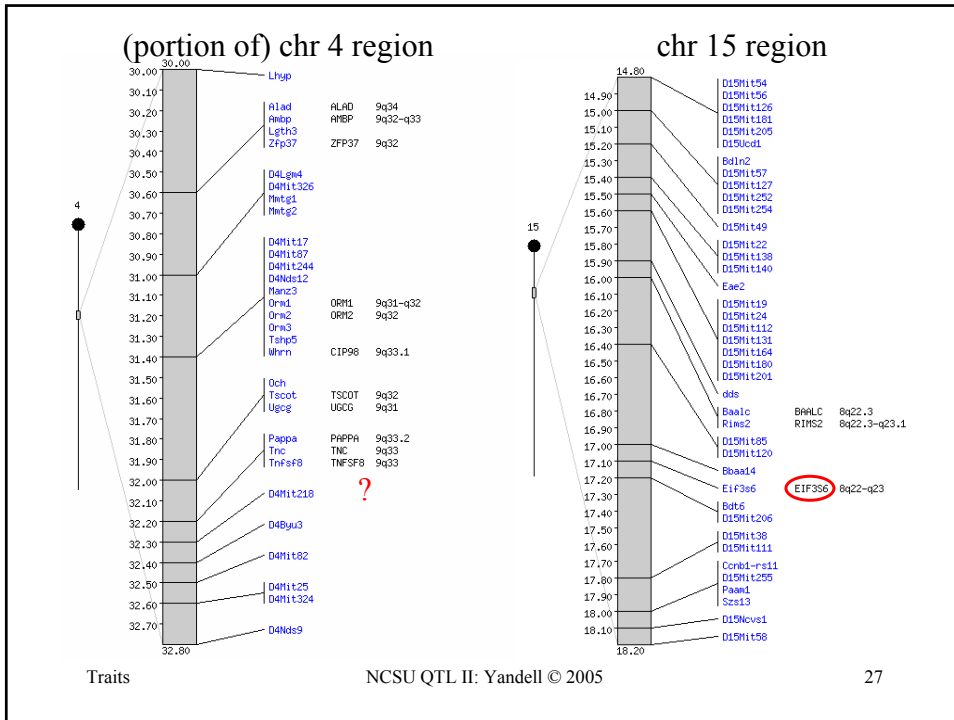

interaction plots for DA meta-traits

DA for all pairs of markers:

separate 9 genotypes based on markers

- (a) same locus pair found with PC meta-traits
- (b) Chr 2 region interesting from biochemistry (Jessica Byers)
- (c) Chr 5 & Chr 9 identified as important for insulin, SCD

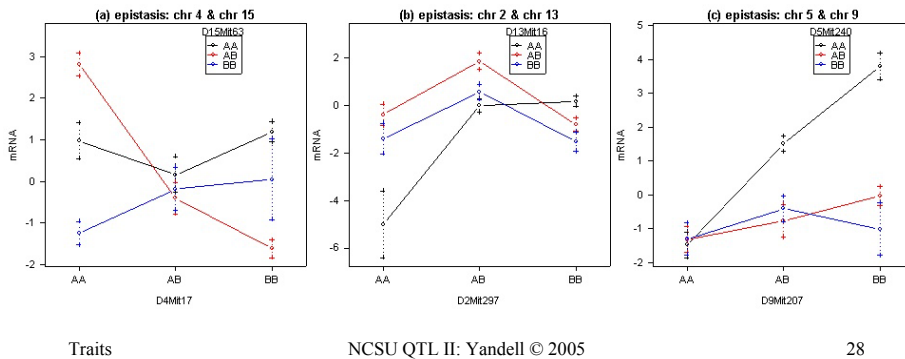

comparison of PC and DA meta-traits on 1500+ mRNA traits

genotypes from
Chr 4/Chr 15
locus pair
(circle=centroid)

PC captures
spread without
genotype

DA creates best
separation by
genotype

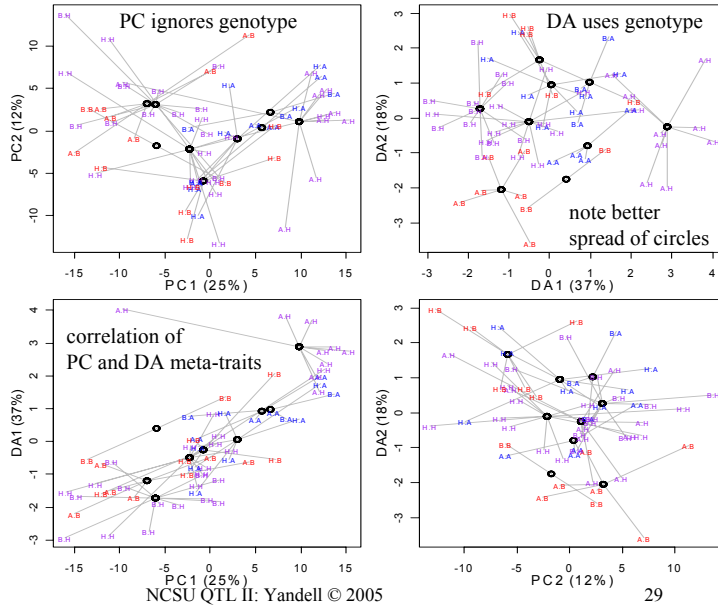

Traits

NCSU QTL II: Yandell © 2005

relating meta-traits to mRNA traits

DA meta-trait
standard units

SCD trait
log₂ expression

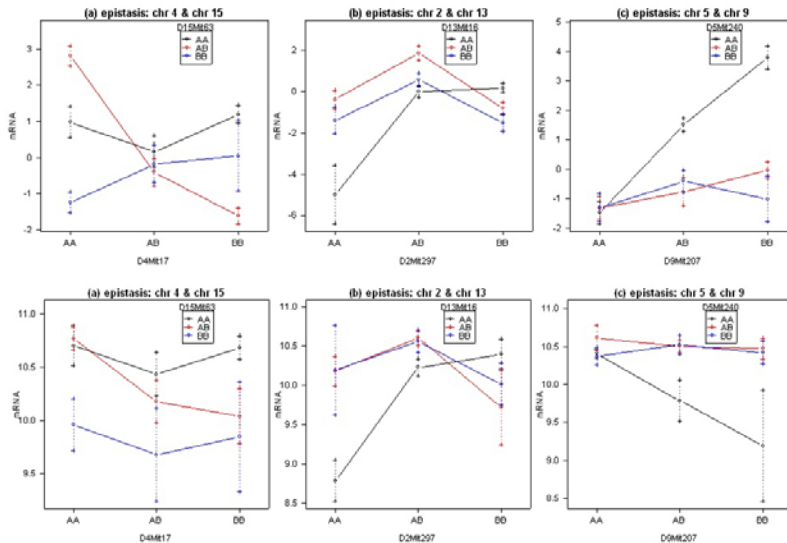

Traits

NCSU QTL II: Yandell © 2005

30

DA: a cautionary tale

(184 mRNA with $|\text{cor}| > 0.5$; mouse 13 drives heritability)

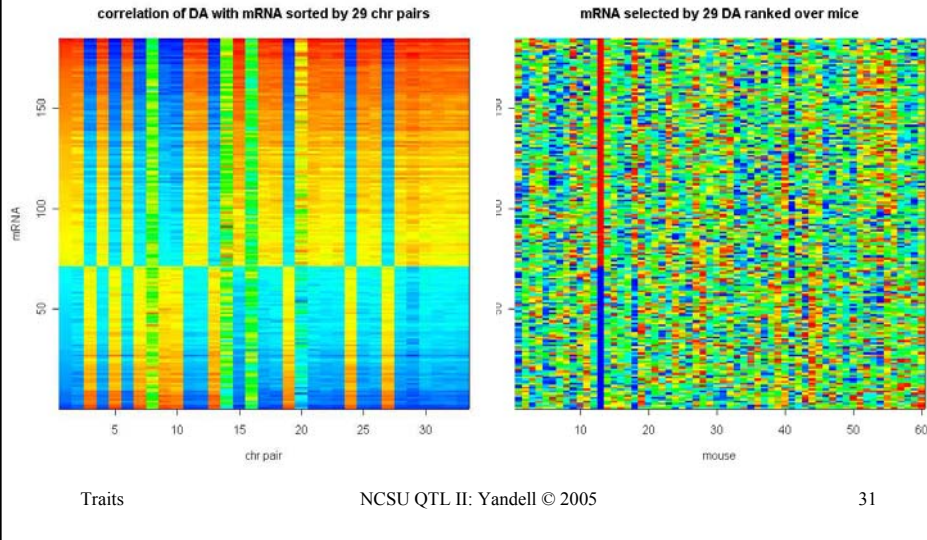

building graphical models

- infer genetic architecture of meta-trait
 - $E(Z | Q, M) = \mu_q = \beta_0 + \sum_{\{q \text{ in } M\}} \beta_{qk}$
- find mRNA traits correlated with meta-trait
 - $Z \approx \underline{Y}W$ for modest number of traits \underline{Y}
- extend meta-trait genetic architecture
 - \underline{M} = genetic architecture for \underline{Y}
 - expect subset of QTL to affect each mRNA
 - may be additional QTL for some mRNA

posterior for graphical models

- posterior for graph given multivariate trait & architecture

$$\text{pr}(G | \underline{Y}, Q, \underline{M}) = \text{pr}(\underline{Y} | Q, G) \text{pr}(G | \underline{M}) / \text{pr}(\underline{Y} | Q)$$

– $\text{pr}(G | \underline{M})$ = prior on valid graphs given architecture

- multivariate phenotype averaged over genotypic mean μ

$$\text{pr}(\underline{Y} | Q, G) = f_1(\underline{Y} | Q, G) = \prod_q f_0(\underline{Y}_q | G)$$

$$f_0(\underline{Y}_q | G) = \int f(\underline{Y}_q | \underline{\mu}, G) \text{pr}(\underline{\mu}) d\underline{\mu}$$

- graphical model G implies correlation structure on \underline{Y}

- genotype mean prior assumed independent across traits

$$\text{pr}(\underline{\mu}) = \prod_t \text{pr}(\mu_t)$$

from graphical models to pathways

- build graphical models

$$\text{QTL} \rightarrow \text{RNA1} \rightarrow \text{RNA2}$$

– class of possible models

– best model = putative biochemical pathway

- parallel biochemical investigation

– candidate genes in QTL regions

– laboratory experiments on pathway components

graphical models (with Elias Chaibub)

$$f_1(\underline{Y} | Q, G=g) = f_1(Y_1 | Q) f_1(Y_2 | Q, Y_1)$$

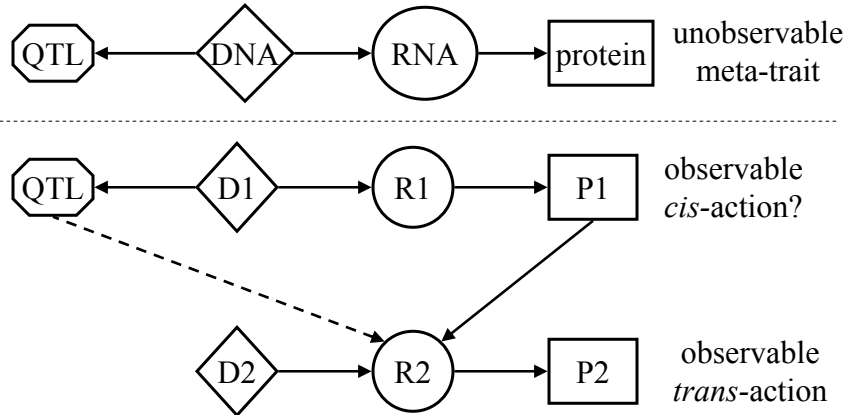

summary

- expression QTL are complicated
 - need to consider multiple interacting QTL
- coherent approach for high-throughput traits
 - identify heritable traits
 - dimension reduction to meta-traits
 - mapping genetic architecture
 - extension via graphical models to networks
- many open questions
 - model selection
 - computation efficiency
 - inference on graphical models